

**Plugging Boxes**

Interior / Exterior Applications



**TL310 SERIES  
Recessed Wall Box**

**Description**

The TL310 Series Plugging Boxes are recessed wall mounted enclosures designed for the temporary connection of electrical devices in interior or exterior applications.

**Features**

The TL310 Series Plugging Boxes have a locking cover to assure protection from improper or unauthorized use. Key is removable only when lock is in "locked" position. Open cover will not fully close without use of key, permitting custodian to tell at a glance whether unit is open or locked. A barrier in the wiring area allows mixed voltage devices within the enclosure.

**Applications**

The TL310 Series Plugging Boxes are appropriate in schools, churches, hospitals and civic buildings for connection of lighting, sound and service appliance equipment.

**Custom**

If your project demands a special fixture we would be pleased to discuss the production of custom fixtures to suit your specific conditions. For more information on our custom capabilities, please contact your local Cole representative.



The TL310 Series wall boxes provide secure, all-weather access to electrical devices.

The TL310 Series wall boxes are available with optional Cast Bronze or custom color covers.



C.W. Cole & Company, Inc.  
2560 Rosemead Boulevard  
South El Monte, CA 91733-1593

Tel. (626) 443-2473  
Fax (626) 443-9253  
info@colelighting.com  
[www.colelighting.com](http://www.colelighting.com)

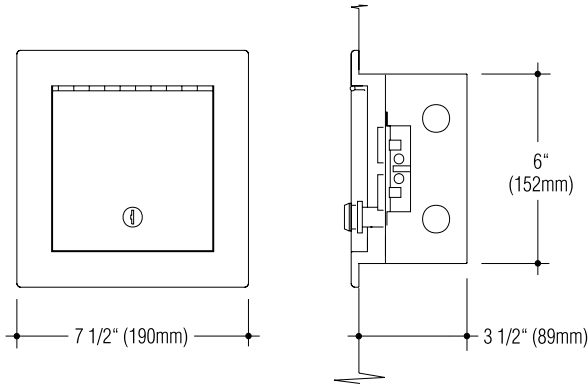

Mounting area for devices: 4" x 4"

## Plugging Boxes

### TL310 SERIES Recessed Wall Box

#### Specifications

##### Construction

- Gasketed doors and frames are cast aluminum, coated in metallic aluminum polyester, with stainless steel piano hinges, and locking or non-locking latches
- All units keyed alike
- Cover is gasketed weathertight
- Recessed housing is die-formed 16 gauge, electro-galvanized steel, coated in white polyester and suitable for installation in concrete pour
- Receptacle mounting plates and voltage barriers are .080" aluminum

##### Electrical

- Factory installed wiring devices or combinations are available as illustrated
- Integrated voltage barrier is provided, allowing low and high voltage devices to be installed in one box
- Recessed housing has eight 1/2", 3/4", 1" combination conduit knockouts, four for each device compartment
- cETLus electrical Metallic Outlet Box listed for installation in wet locations

##### Mounting

- Interior or exterior stud wall or concrete pour

#### Catalog Numbers

Blank interior plate. No device furnished

TL310

#### Device Options

**Ground Fault Circuit Interrupter:** Weather resistant/tamper resistant receptacle.

Add suffix **-GFCI/WR/TR**

**Phone/Ethernet:** Telephone or data connection in modular Decora® cutout. Add suffix **-RJ11** or **-RJ45**

**Standard cable connection interface:** Universal Serial Bus port. Add suffix **-USB**







**Audio/video interface:** High-definition multimedia interface. Add suffix **-HDMI**

**Microphone connector:** XLR 3-pole, jack, panel mount. Add suffix **-MIC**

**Speaker connector:** XLR 4-pole, jack, panel mount. Add suffix **-SPKR**

**Customer specific:** Specify device or desired provisions. Add suffix **-9/(device or provisions)**

#### TL310 Device Capacity Chart

						
<b>-GFCI</b> duplex w. circuit breaker	<b>-RJ11</b> 1-6 jacks per insert	<b>-RJ45</b> 1-6 jacks per insert	<b>-USB</b> 1-6 ports per insert	<b>-HDMI</b> 1-6 ports per insert	<b>-SPKR</b> single	<b>-MIC</b> single
<b>Maximum inserts per housing = 2</b>					<b>= 6</b>	
Mixed and matched quantities not to exceed total in any column.						

#### Options

**Cast Bronze Cover:** Satin finished red brass. Add suffix **-B**.

**Concrete Mount:** Add suffix **-C**.

**No Key:** Add suffix **-NK**.

**Additional Conduit Entries:** Specify size and locations. Add suffix **-KO**.

**Custom Color:** Contact factor. Add suffix **-CC**

#### How to Specify

1. Select catalog number with desired features.
2. Add suffixes for options required to meet job conditions.



**C.W. Cole & Company, Inc.**  
2560 Rosemead Boulevard  
South El Monte, CA 91733-1593

Tel. (626) 443-2473  
Fax (626) 443-9253  
info@colelighting.com  
[www.colelighting.com](http://www.colelighting.com)