

JOB NAME _____

CONTACT _____

ORDERING CODE _____

Zeta750 Snap

Recessed Module - Snap In Static White or RGBW



DESCRIPTION

Zeta750 Snap features a patented design with a collapsible thread. With one easy push, the module snaps securely into the rail. Removal is only possible with a unique extraction tool. Most cost effective rail solution on the market. Field or OEM handrail installation. Series shunt bypass ensures remaining operate if single puck failure (exception: RGBW).

HOUSING

Extremely durable 316 stainless steel marine grade electro-polished housing, with 3.5" (90mm) 20AWG wire leads.

MOUNTING

- Install in metallic surface only for proper thermal dissipation. Luminaire is for use in non-insulated recessed surfaces
- Rail Size - min. D 1-3/8", 35mm
- Rail Wall Thickness - min. 1/16", 1.5mm
- Curved or flat mounting surfaces
- Aperture for Flat face - 15mm or 15mm + (16mm x 0.5mm) counterbore (required for flush finish)
- Aperture for Curved face - 15mm or 15mm + (16mm x 1.5mm) counterbore (required for flush finish)

ELECTRICAL/LED Driver

- 3Vdc, 500mA, 1.5W (Remote Driver Required)
- RGBW 500mA single emitter or total system 4 x 125mA
- Cool splice connector included
- Ambient operating temperature: -40°C to + 55°C
- Series shunt bypass ensures remaining operate if single puck failure (exception: RGBW)

LISTINGS

- ETLus Listed to UL2108 (suitable for wet locations)
- cETL Listed to CSA C22.2 #250.0
- Impact tested to IK10 (EN62262) PC lens only
- IP65 rated with PC lens
- IP67 rated with Borosilicate glass lens
- IP68 rated to 6.5ft at 24hrs (NOT FOR PERMANENT SUBMERSION)
- ADA Compliant when using handrail diameter 1-7/16" (36mm) to 2" (50.8mm) O.D
- 3000k or warmer must be selected for International Dark-Sky Association approval.

LED INFO

- LED: Cree Xlamp® XP-G3 (applicable for Static White)
Cree Xlamp® XM-L Color (applicable for RGBW)
Cree Xlamp® XP-GA (Amber-590nm *Dominant Wavelength* complies with Wildlife and Marine Turtle safe-lighting requirements)
- Duv: 0.001
- CCT: 2700K, 3000K, 3500K, 4000K, RGBW, amber
- CRI: >80
- Lumen Maintenance: L₉₀ > 90,700 hrs (Static White)
- Warranty: 5 year limited warranty

ORDERING CODE

SERIES	750S	snap puck
CCT	27K	2700K
	30K	3000K
	35K	3500K
	40K	4000K
	RGBW ^{1,3}	RGBW
	AMB	amber
BEAM	ST ²	70° standard
	VA ²	75° asymmetric
	WD ³	105° wide
	HYP ³	75° hyperbolic
LENS	PC	polycarbonate - IP65
	BG	borosilicate glass - IP67
	IP68	optically clear polyurethane - IP68
FACE TYPE	CF	curved face
	FF	flat face

ORDERING CODE

Follow the steps to specify your fixture, example:

750S - 27K - ST - PC - FF

LUMENS FOR ST/VA/WD BEAM OPTION	
LUMENS (LM)	CCT (K)
165	2700
170	3000
175	3500
180	4000
145	amber

LUMENS FOR HYP BEAM OPTION	
LUMENS (LM)	CCT (K)
85	2700
90	3000
95	3500
100	4000
77	amber

LUMENS FOR IP68 LENS OPTION	
LUMENS (LM)	CCT (K)
115	2700
120	3000
125	3500
130	4000
102	amber

See page 7 for Design Guide.

NOTES

1. RGBW only available in ST beam option. W CCT at 4000K.
2. ST 60° and VA 85° when using IP68 Lens.
3. Not Available in IP68.

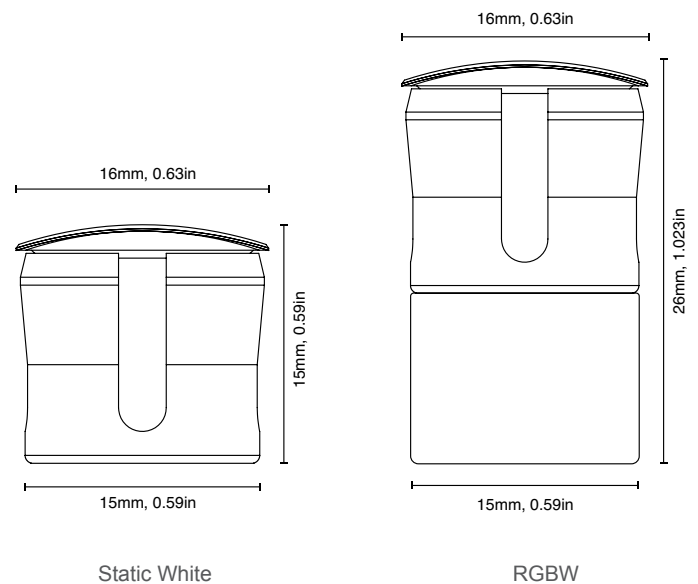

STATIC WHITE - STANDARD BEAM

ZETA750 Snap Standard has an elliptical symmetric distribution. For installation in handrail, mounting is typically at 30° from the vertical axis of the handrail underside. Snap is available in a range of distributions and special angles on request. Asymmetrical beam, see page 3.

ZETA750 SNAP ST - STATIC WHITE
CURVED FACE DETAIL

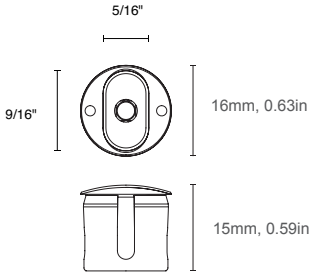

ZETA750 SNAP ST - STATIC WHITE
FLAT FACE DETAIL

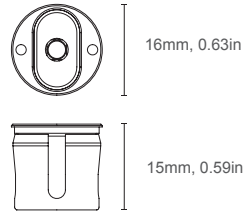

ZETA750 SNAP ST - STATIC WHITE
BEAM ALPHA 3000K

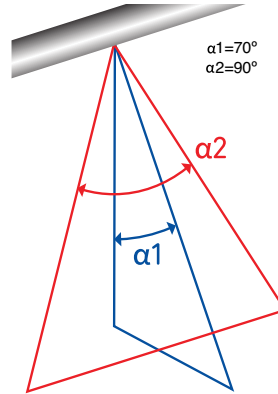

ZETA750 SNAP ST - STATIC WHITE
STANDARD BEAM

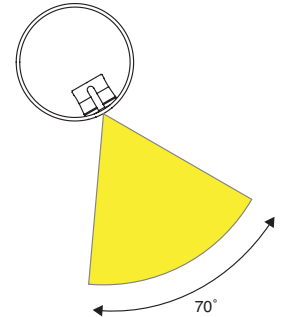

Elliptical symmetric distribution for typical mounting at 30° from vertical.

ZETA750 SNAP ST 30
STANDARD SYMMETRICAL BEAM 3000K

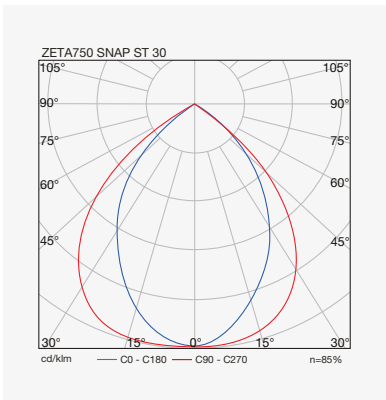

ZETA750 SNAP ST - STATIC WHITE IP68
BEAM ALPHA 3000K

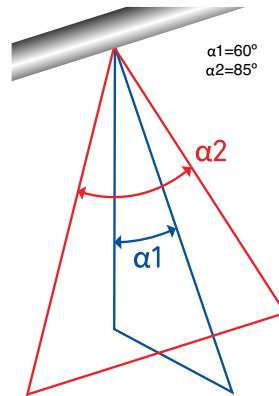

ZETA750 SNAP ST - STATIC WHITE
STANDARD BEAM IP68

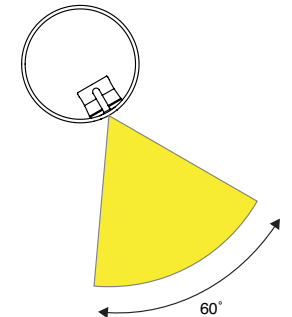

Elliptical symmetric distribution for typical mounting at 30° from vertical.

ZETA750 SNAP ST 30 IP68
STANDARD SYMMETRICAL BEAM 3000K

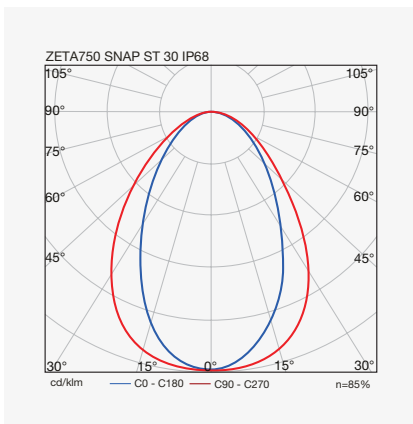

STATIC WHITE - ASYMMETRICAL BEAM

ZETA750 Snap Asymmetric has an elliptical asymmetric distribution. Designed for insertion at 0-10 degrees from the vertical axis of the handrail underside. The asymmetric beam illuminates the path but keeps the light source out of sight. Snap is available in a range of standard distributions and special angles on request.

ZETA750 SNAP VA - STATIC WHITE CURVED FACE DETAIL

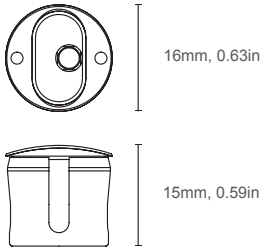

ZETA750 SNAP VA - STATIC WHITE FLAT FACE DETAIL

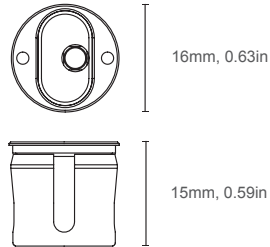

ZETA750 SNAP VA - STATIC WHITE BEAM ALPHA 3000K

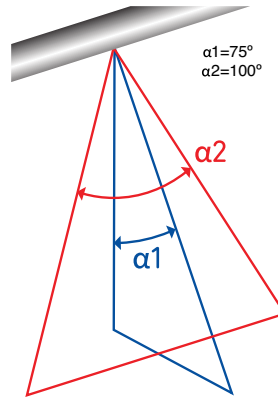

ZETA750 SNAP VA - STATIC WHITE ASYMMETRICAL BEAM

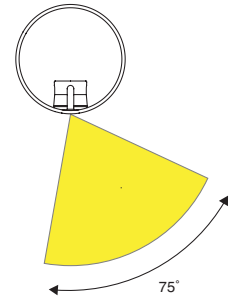

Elliptical asymmetric distribution displayed here with a vertical mount.

ZETA750 SNAP VA 30 ASYMMETRICAL BEAM 3000K

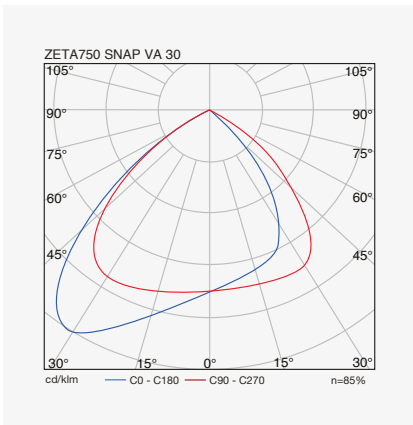

ZETA750 SNAP VA - STATIC WHITE IP68 BEAM ALPHA 3000K

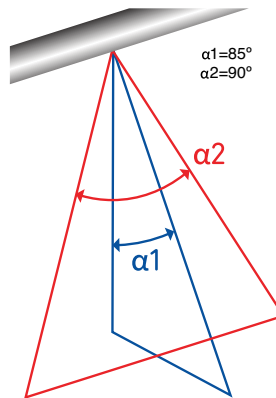

ZETA750 SNAP VA - STATIC WHITE ASYMMETRICAL BEAM IP68

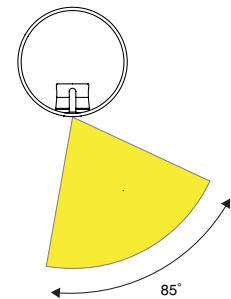

Elliptical asymmetric distribution displayed here with a vertical mount.

ZETA750 SNAP VA 30 IP68 ASYMMETRICAL BEAM 3000K

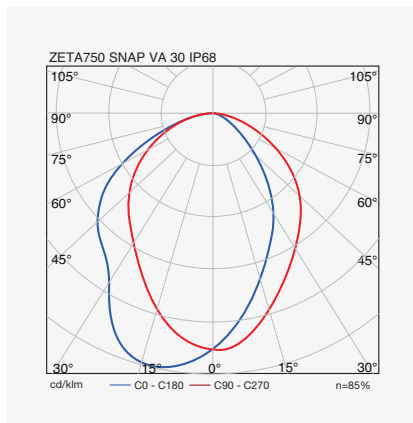

STATIC WHITE - WIDE BEAM

ZETA750 Snap Wide has a specially designed very wide elliptical distribution with no sharp cut off. Typical for mounting in the underside of a handrail at vertical down position.

ZETA750 SNAP WD - STATIC WHITE
CURVED FACE DETAIL

ZETA750 SNAP WD - STATIC WHITE
FLAT FACE DETAIL

ZETA750 SNAP WD - STATIC WHITE
BEAM ALPHA 3000K

ZETA750 SNAP WD - STATIC WHITE
WIDE BEAM

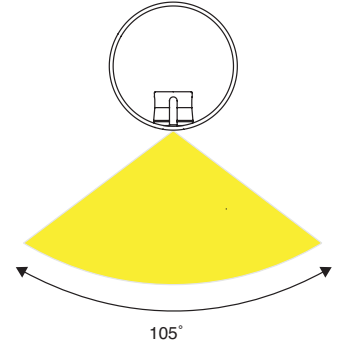
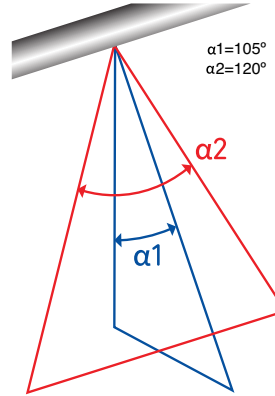
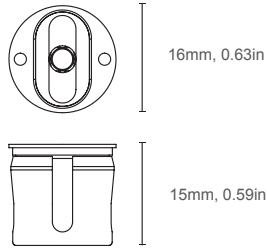
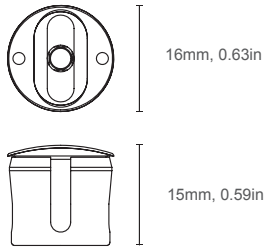

Wide elliptical distribution displayed here with a vertical mount

ZETA750 SNAP WD 30
WIDE BEAM 3000K

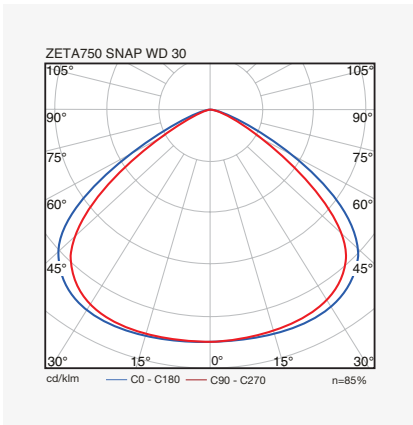

STATIC WHITE - HYPERBOLIC BEAM

ZETA750 Snap Hyperbolic has an elliptical asymmetric distribution. Designed for insertion at 0-10 degrees from the vertical axis of the handrail underside. The asymmetric beam illuminates the path but keeps the light source out of sight. Hyperbolic is available in a range of standard distributions and special angles on request.

ZETA750 SNAP HYP - STATIC WHITE
CURVED FACE DETAIL

ZETA750 SNAP HYP - STATIC WHITE
FLAT FACE DETAIL

ZETA750 SNAP HYP - STATIC WHITE
BEAM ALPHA 3000K

ZETA750 SNAP HYP - STATIC WHITE
HYPERBOLIC BEAM

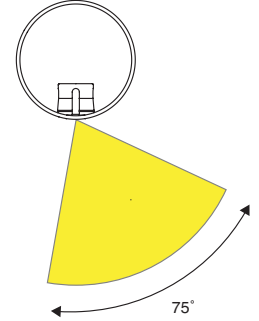
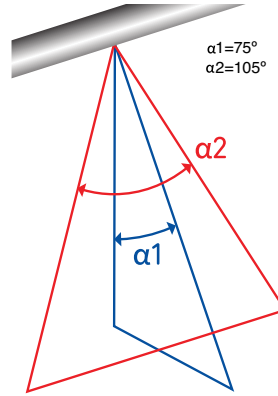
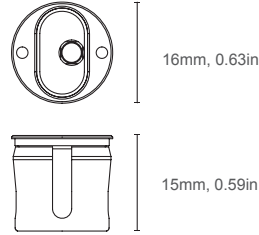
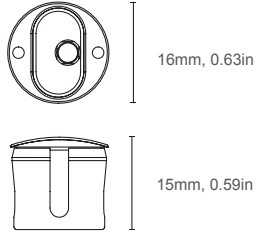

Elliptical asymmetric distribution displayed here with a vertical mount.

ZETA750 SNAP HYP 30
HYPERBOLIC BEAM 3000K

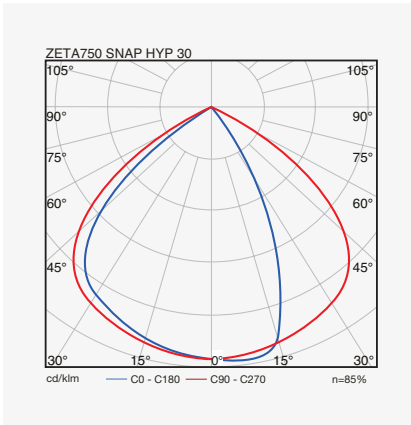

RGBW - STANDARD BEAM

RGBW has an elliptical symmetric distribution. For installation in handrail, mounting is typically at 30° from the vertical axis of the handrail underside. RGBW is available in a range of distributions and special angles on request.

ZETA750 SNAP ST - RGBW
CURVED FACE DETAIL

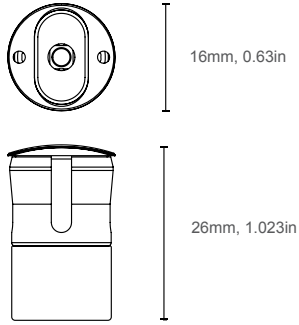

ZETA750 SNAP ST - RGBW
FLAT FACE DETAIL

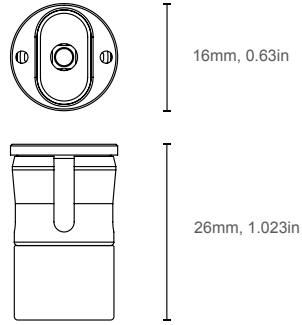

ZETA750 SNAP ST - RGBW
BEAM ALPHA 3000K

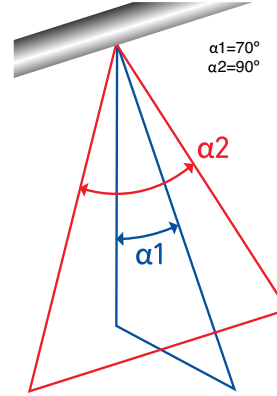

ZETA750 SNAP ST - RGBW
STANDARD BEAM

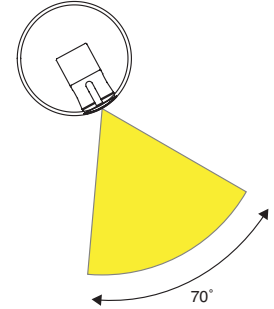

Elliptical symmetric distribution for typical mounting at 30° from vertical.

ZETA750 SNAP SOLO ST - RGBW (W 40)
STANDARD SYMMETRICAL BEAM 4000K
(Results displayed were obtained using white chip at 500mA)

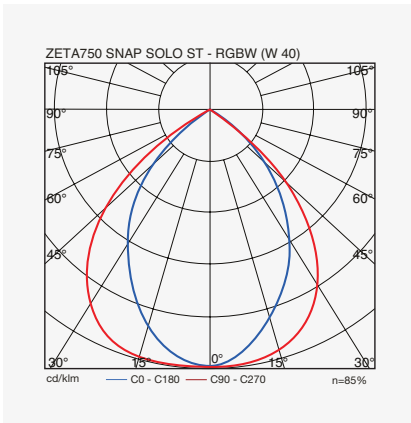

SPACING GUIDE

The following guide is intended to help designers and engineers with desired foot-candle levels. The drawing to the right shows a typical installation into a handrail. The tables list the average foot-candles at a variety of path widths and LED spacings

TYPICAL INSTALLATION

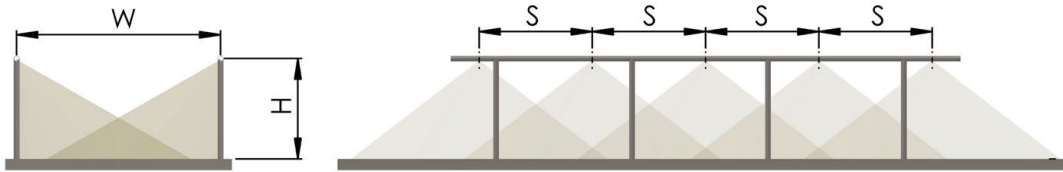

Height (H) is at 3'-1/4"

STATIC WHITE - STANDARD BEAM IP65-67/IP68: LIGHT FROM BOTH SIDES

PATH WIDTH (W)	4ft	6.5ft	10ft	13ft
LED SPACING (S)	fc	fc	fc	fc
1.5ft	32/18	19/11	13/7	10/5
3ft	16/9	10/5	6/3.5	5/2.7
6.5ft	8/4.5	5/2.7	3/1.8	2/1.3

fc = average foot-candles
CCT = 3000K

NOTE: Calculations indicated are with LED module installed at 30° offset from vertical down axis.

STATIC WHITE - ASYMMETRICAL BEAM IP65-67/IP68: LIGHT FROM BOTH SIDES

PATH WIDTH (W)	4ft	6.5ft	10ft	13ft
LED SPACING (S)	fc	fc	fc	fc
1.5ft	27/16	16/9.5	11/6.3	8/4.7
3ft	14/8	8/4.7	5/3	4/2.4
6.5ft	7/4	4/2.4	3/1.5	2/1.2

fc = average foot-candles
CCT = 3000K

NOTE: Calculations indicated are with LED module in vertical down position.

STATIC WHITE - WIDE BEAM: LIGHT FROM BOTH SIDES

PATH WIDTH (W)	4ft	6.5ft	10ft	13ft
LED SPACING (S)	fc	fc	fc	fc
1.5ft	21	12	8	6
3ft	10	6	4	3
6.5ft	5	3	2	1.5

fc = average foot-candles
CCT = 3000K

NOTE: Calculations indicated are with LED module in vertical down position.

STATIC WHITE - HYPERBOLIC BEAM: LIGHT FROM BOTH SIDES

PATH WIDTH (W)	4ft	6.5ft	10ft	13ft
LED SPACING (S)	fc	fc	fc	fc
1.5ft	15	9	6	4.5
3ft	8	4.5	3	2.3
6.5ft	4	2.3	1.5	1

fc = average foot-candles
CCT = 3000K

NOTE: Calculations indicated are with LED module in vertical down position.

RGBW (W CCT at 4000K) - STANDARD BEAM: LIGHT FROM BOTH SIDES

PATH WIDTH (W)	4ft	6.5ft	10ft	13ft
LED SPACING (S)	fc	fc	fc	fc
1.5ft	35	21	14	11
3ft	18	11	7	5
6.5ft	9	5	4	3

fc = average foot-candles
CCT = 4000K

NOTE: Calculations indicated are with LED module installed at 30° offset from vertical down axis and obtained using white chip at 500mA.

ZETA750 SNAP TOOL KIT - FOR ROUND OR SQUARE HANDRAIL



Product Number: 750-TOOL KIT ZETA SNAP

- 1 1 x Drill Jig unit pre-installed with 1 x 15 and 16mm cutters
- 2 1 x Flat Face Spacer (for use ONLY with Flat face / Square Pipe).
Not Shown.
- 3 1 x Drilling manual (this guide)
- 4 2 x 15mm cutters (spares)
- 5 1 x 16mm cutter (spare)
- 6 1 x Cutter removal tool (double-sided)
- 7 1 x 2mm Allen (hex) key
- 8 2 x cutting lubricant
- 9 1 x AF 10mm nut driver
- 10 1 x 10mm wrench
- 11 1 x Insertion pliers
- 12 1 x File

* Not shown, wire crimping pliers.

Purchases

- It is strongly recommended to purchase a kit or multiple kits for larger projects or projects with several phases.
- Additional drill bits jig assemblies can be purchased at nominal cost to replace worn or ineffective parts. CONSULT FACTORY.

NO TOOL KIT REQUIRED - FOR FLAT SURFACES

- Drill 15mm hole in mounting surface