

Steplites

Series	LED	Junction Box	E26/Med. Base	Dimming	Exterior	Interior	Feed-Thru	Other Options
157	•	•	•	•	•	•	•	Bronze faceplate LED colors Sharp cutoff louver Faceplate colors

157 SERIES

Description

This compact Steplite with its standard louver, sharp cut-off louver, and non-louvered options is one of our most popular series. It is appropriate for a variety of interior or exterior applications. The rugged construction, engineering excellence, and quality make these fixtures ideal for specification in most public areas.

Features

Louvers in the 157 Series are more widely spaced than most fixtures of this type, allowing for significantly greater forward projected illumination. Exceptional durability is provided by the thick cast aluminum faceplate and the tempered glass diffuser. Louvered models offer even greater protection to the diffuser while controlling the distribution of light. Cole Steplites feature an optional cast aluminum junction box which may be easily field mounted to either the back or bottom of the housing to best suit installation conditions.

Applications

The L157 Series Steplites are suitable for concrete pour/block wall and stud wall mounting in indoor or outdoor installations. They are ideal in low walls and side mounting at stairs. LED modules will work well in extremely cold climates.

Custom

If your project demands a special fixture we would be pleased to discuss the production of modified standard fixtures or custom fixtures to suit your specific conditions. For more information on our custom capabilities, please contact your local Cole representative.



L157W-WHT-J — White Faceplate



T157GW -J — E26 medium base lamp



SL157W — Surface LED



L157W-2S-SCL-BLK — Thru-wall

Surface housing features tapped conduit entries.



157 Series Steplites are available with wide louvers, sharp cutoff louvers and non-louvered faceplates.



The junction box on Cole Steplites may be field mounted to the back or bottom of the fixture.

SL157W-B surface option, includes Cast Bronze faceplate and housing.



COLE
Lighting

C.W. Cole & Company, Inc.
2560 Rosemead Boulevard
South El Monte, CA 91733-1593

Tel. (626) 443-2473
Fax (626) 443-9253
info@colelighting.com
www.colelighting.com

Louver

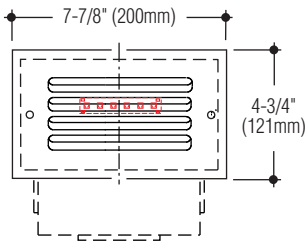

LED Module

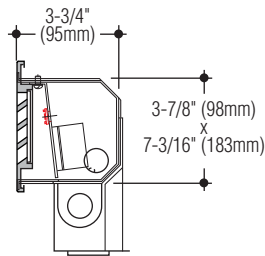

Double-sided

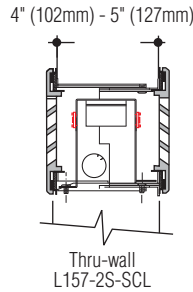

Steplites

157 SERIES

SPECIFICATIONS

Construction

- Recessed housing is constructed from die-formed 16 gauge electro-galvanized steel and is coated with white polyester
- Surface housing is cast aluminum with metallic aluminum polyester coating
- Faceplate is cast aluminum with metallic aluminum polyester coating, gasketed and retained by stainless steel screws
- Diffuser is frosted tempered glass, set in silicone sealant
- Optional junction box is cast aluminum with polyester coating
- cETLus listed, suitable for wet locations in any wall construction
- Suitable for any wall construction
- All models suitable for wet locations.

Electrical

- Fixture is wired with high performance LED modules, or one E26 medium base lamp socket
- Integral driver is standard universal voltage; optional 0-10V dimming driver available
- Standard recessed and surface housing allows for 4 thru-wiring, 2 in and 2 out
- Housing provided with 1/2" conduit knockout on each side suitable for 4 wire thru-wiring, 2 in and 2 out
- Optional junction box allows 8 wire thru-wiring, 4 in and 4 out. Provided with two 1/2" tapped conduit entrances in the bottom and one 1/2" tapped conduit entrance in each side.

Mounting

Housing has flange with holes for mounting.

Sharp cutoff louver

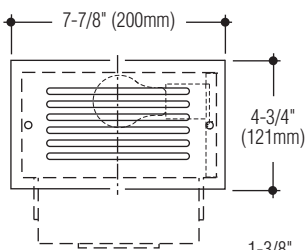

E26 med. base socket

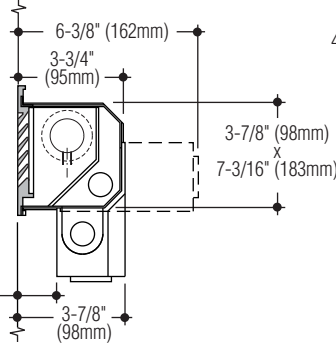

Double-sided

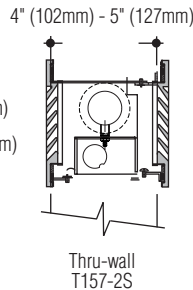

Louver

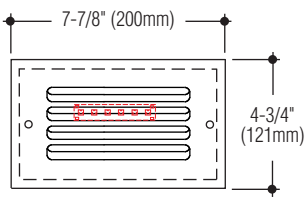

Surface

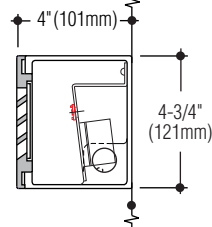

Non-Louver

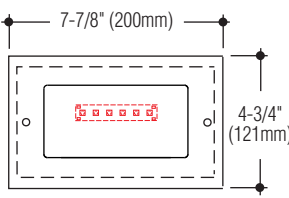

Catalog Numbers	Recessed Fixtures		Thru-Wall		Surface Fixtures	
	Faceplate		Faceplates		Faceplate	
Lamp	Louver	Non-Louver	Louver	Non-Louver	Louver	Non-Louver
LED 1.5W, (126 lm @ 3000°K)*	L157W	L157GW	L157W-2S	L157GW-2S	SL157W	SL157GW
LED 3.4W, (331 lm @ 3000°K)*	L157W-HO	L157GW-HO	L157W-2S-HO	L157GW-2S-HO	SL157W-HO	SL157GW-HO
LED 6.8W, (662 lm @ 3000°K)	L157W-HO-2	L157GW-HO-2	—	—	SL157W-HO-2	SL157GW-HO-2
One E26 medium base lamp	T157W	T157GW	T157W-2S	T157GW-2S	ST157W	ST157GW

Lumens shown are source. *Indicated values for wattage and lumens doubled for thru-wall models.
Photometric data available for Steplites can be downloaded at: <https://www.colelighting.com/photometrics>

Options

Junction box: Bottom or back mounted junction box for feed-thru. Add suffix **-J** (Not available with surface or thru-wall models).

Sharp cutoff louver: Below horizontal illumination, cast aluminum. Add suffix **-SCL**.

Cast Bronze faceplate and surface housing: Satin finish, clear coated. Add suffix **-B**.

Stainless steel housing: 16 gauge stainless steel recessed housing. Add suffix **-SS**.

Alternate faceplate color: Black, white or custom color. Add suffix **-BLK**, **-WHT** or **-CC**.

Opal glass diffuser: Tempered. Add suffix **-OPL**.

Tamperproof screws: Socket head faceplate screws. Add suffix **-TP**.

Dimming: Universal voltage, 0-10V driver. Add suffix **-DIM**.

Emergency battery (4 Watt): Provides up to 90 minutes operation. Add suffix **-EM**.

LED colors:
4100°K (146 lm), **-HO** (384 lm), **-HO-2** (768 lm).
 Add suffix **-4K**.

Amber* (FWC compliant, 590 nm). Add suffix **-AMB**.

Blue* Add suffix **-BLU**.

* Not available in HO-2.

How to Specify

1. Select catalog number with desired features.
2. Add suffixes for options required to meet job conditions.



C.W. Cole & Company, Inc.
 2560 Rosemead Boulevard
 South El Monte, CA 91733-1593

Tel. (626) 443-2473
 Fax (626) 443-9253
info@colelighting.com
www.colelighting.com